



# SS1410HP

SAFARI ARMAX SNORKEL  
VOLKSWAGEN AMAROK V6 TDI550  
3.0L TDI V6 Engine



10/04/2018

## Parts List

ITEM	PART NO.	DESCRIPTION	QTY
1	910-133-600	BODY - SNORKEL (SS1410HP)	1
2	000-135-960	4" AIR RAM ASSEMBLY	1
3	910-032-600	BRACKET - UPPER MOUNTING	1
4	000-002-100	BOLT - HEX - 6mm x 1.0 x 14mm (SEMS)	2
5	000-951-300	SCREW - S/T - 4.2mm x 16mm - S/S	3
6	000-960	INSERT - PLASTIC	3
7	000-110	STUD - 8mm x 1.25 x 25mm - S/S	5
8	000-311-300	WASHER - BODY - 8mm x 30mm - S/S	5
9	000-205-300	NUT - NYLOC - 8mm x 1.25mm - S/S	5
10	910-024-600	HOSE - AIR ENTRY (Flanged Mounting)	1
11	910-025-600	PLATE - CLAMPING - (Upper)	1
12	910-025-625	PLATE - CLAMPING - (Rear)	1
13	910-025-650	PLATE - CLAMPING - (Front)	1
14	910-025-675	PLATE - CLAMPING - (Lower)	1
15	910-025-700	PLATE - AIR FILTER ELEMENT SUPPORT	1

16	000-958-175	POP RIVET - 4mm x 17mm	13
17	000-300-350	WASHER - BODY - 4mm x 12mm - S/S	4
18	910-959-000	CAP - AIR INLET BLANK-OFF	1
19	000-908	CLAMP - HOSE - 70/90mm - S/S	1
20	000-910	CLAMP - HOSE - 90/110mm - S/S	1
21	000-1931/B	CLAMP - HOSE - No. 64 (BLACK)	1
22	910-967-600	PLATE - INNER GUARD SUPPORT	1
23	910-967-650	PLATE - INNER GUARD SUPPORT SPACER	1
24	000-958-525	POP RIVET - 4.8mm x 10mm	8
25	910-967-625	PLATE - INTERNAL INNER GUARD REINFORCEMENT	1
26	000-038-300	BOLT - B/H CAP SCREW - 6.0 x 1.0 x 12mm - S/S	7
27	000-353	WASHER - BODY - 6.0 x 18mm - S/S	7
28	000-204	NUT - NYLOC - 6.0 x 1.0mm - S/S	7
29	910-217-600	TEMPLATE - AIR CLEANER INLET (Side Upper)	1
30	910-217-700	TEMPLATE - AIR CLEANER INLET (Side Lower)	1
31	910-217-800	TEMPLATE - AIR CLEANER INLET (Lower)	1
32	910-017-700	TEMPLATE - INNER GUARD	1
33	910-017-750	TEMPLATE - INTERNAL INNER GUARD	1
34	910-017-600	TEMPLATE - GUARD PANEL	1



# SS1410HP

SAFARI ARMAX SNORKEL  
VOLKSWAGEN AMAROK V6 TDI550  
3.0L TDI V6 Engine

## Installation Guide

### Fitment to:

- Right Hand Side

### Fitting Time:

- 240min

### Special Tools:

- Body Saw (Reciprocating)
- Step Drill
- 4.0mm & 5.0mm Drill Bits
- 6.0mm & 6.5mm Long Series Drill Bits
- Pop Rivet Gun
- Grinder & Files
- Masking Tape
- Touch-up Paint
- Prep-wash
- Sikaflex 227 Adhesive Sealant
- Loctite 243 (Thread Lock)
- Trolley Jack and Jack Stand

**Prior to commencing the installation, it is the installer's responsibility to verify that all components and particularly the guard panel template (Item 34) are correct.**

**1**

Using a suitable Trolley Jack, jack up the vehicle and remove the front right-hand wheel, lower the vehicle onto a suitable jack stand.

**2**

Remove the following in accordance with the factory service manual:

- Mud Flap (Right Hand Front)
- Guard Liner (Right Hand Front)
- Windscreen Washer Bottle Filler Neck
- Windscreen Washer Bottle
- Air Cleaner Lid
- Air Cleaner Base
- Side Indicator (if fitted to vehicle)

**3**

Remove and discard the air cleaner inlet duct.



4

Remove and discard the perforated section of the guard panel template (item 34) as shown.

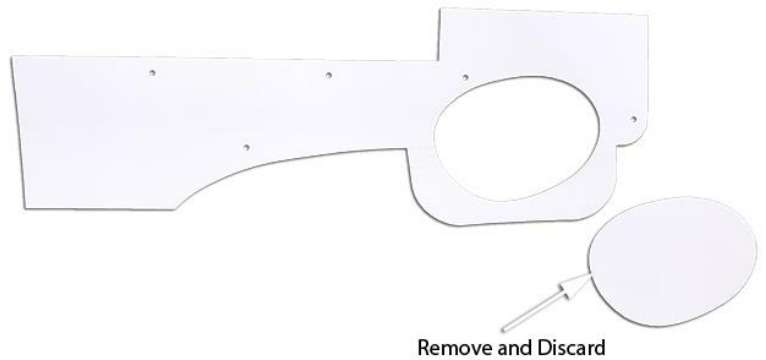

5

Align the guard panel template (Item 34) to the rear and upper edges of the right hand guard panel.

Ensure the template follows the crease in the guard panel and flare as shown.

Tape the template to the guard panel with masking tape.

Mark all five mounting hole positions and the main cut out section with a felt tip pen.

Remove the template.

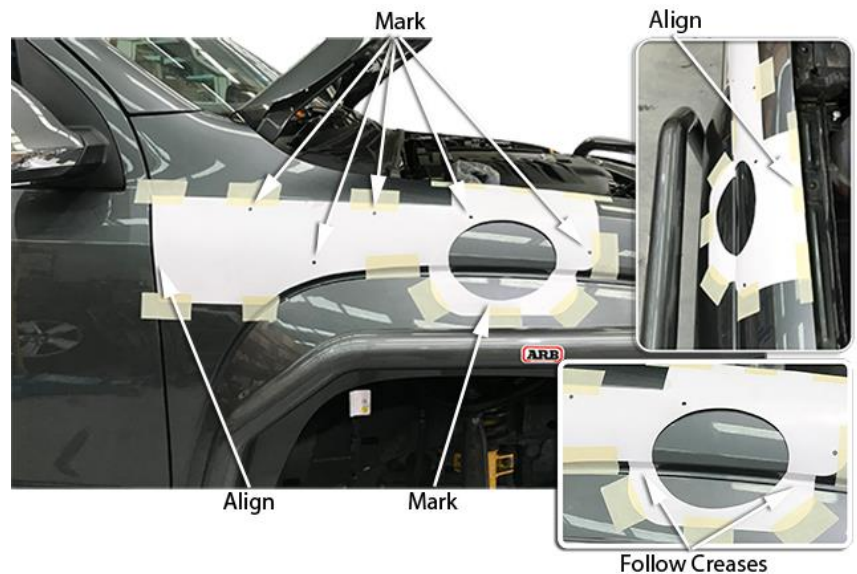

6

Apply masking tape to guard panel and flare to ensure no metal filings are trapped between the flare and guard panel as shown.

Drill a pilot hole for each of the marked hole positions, using a step drill, drill the five mounting holes to 16mm diameter.

Drill 2 or 3, 10mm diameter holes in the cut-out section for a start/stop point for the body saw, using the body saw cut the main hole in the guard panel as marked from the template cut-out in step 5, cutting through both the flare and guard panel in the lower section of the hole.

Deburr all holes and the main cut-out section of the guard panel.

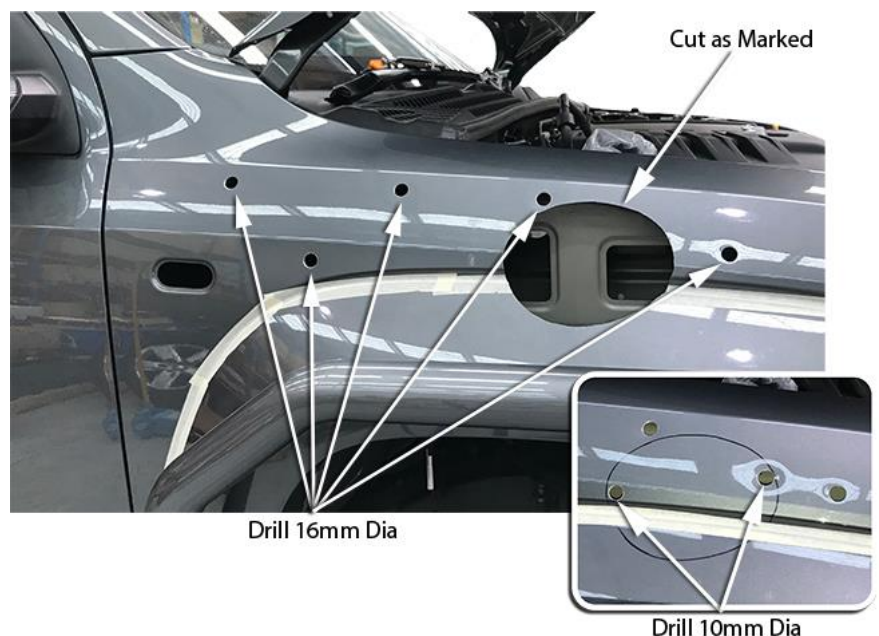

7

Unclip the wiring loom and coolant by-pass hose from the mounting positions.

Remove and discard the two mounting clips (shown) from the wiring loom.

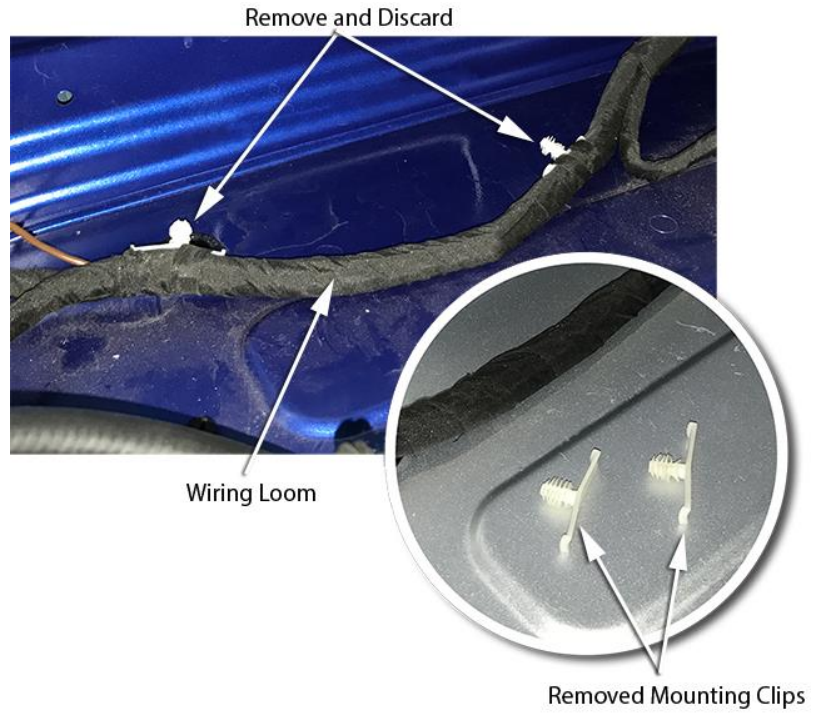

8

Remove and retain the inner guard liner mounting clip (shown) from the inner guard panel.



9

Align the inner guard template (item 32) to the top edge, wiring loom mounting hole and the coolant by-pass rectangle mounting slots of the inner guard panel as shown.

Tape the template to the inner guard panel with masking tape. Ensure the template follows the contours of the inner guard panel.

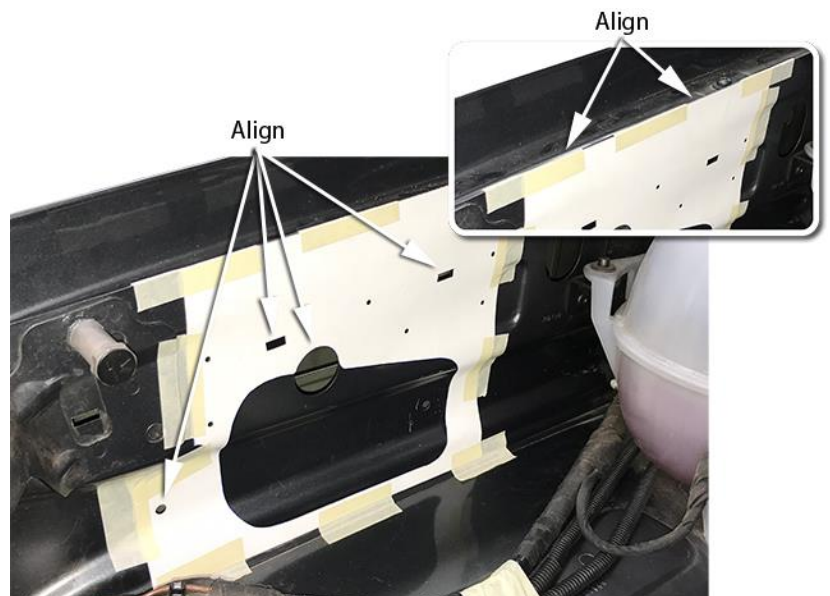

10

With the template correctly taped to the inner guard panel, mark the required cut-out and the six hole positions onto the inner guard panel as shown.

Remove the template.

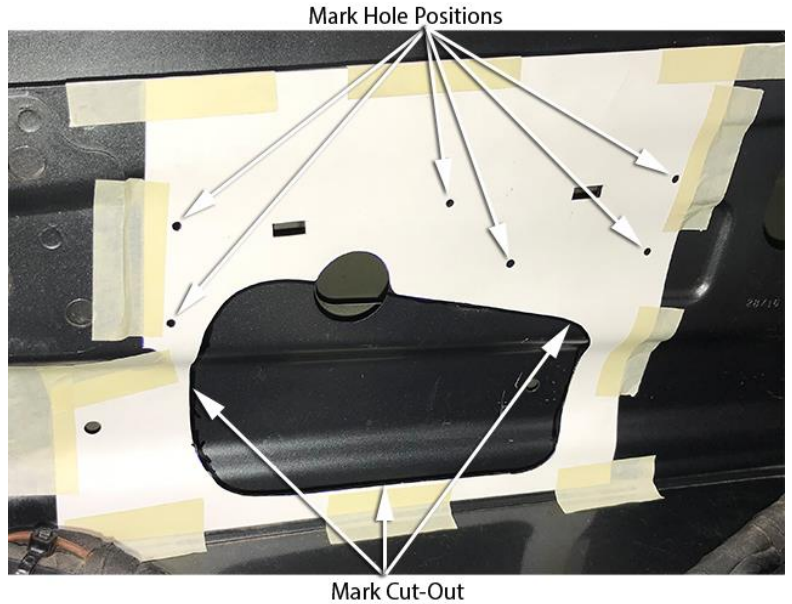

11

Drill a pilot hole at each of the marked hole positions.

Drill the six hole position to 5.0mm diameter.

Using the body saw, cut the hole in the inner guard panel (cutting on the outside of the line), as marked from the template.

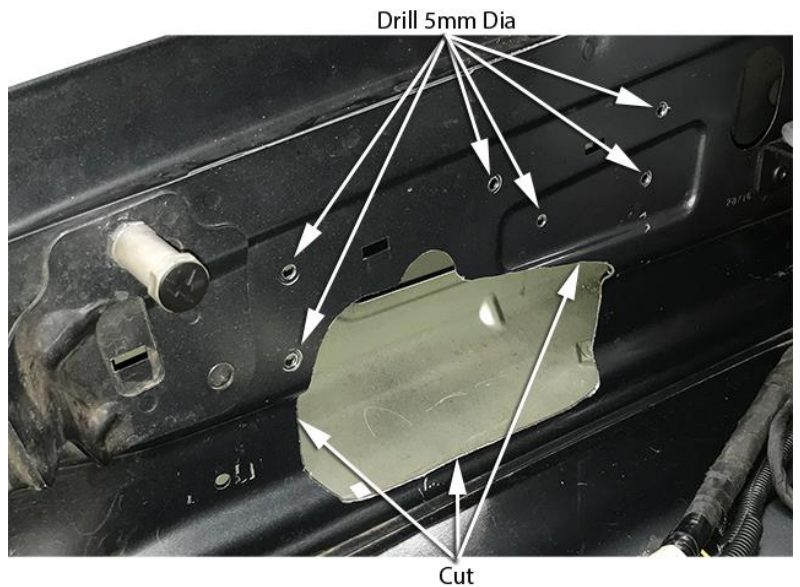

12

Align and tape the inner guard support spacer plate (item 23) to the inner guard support plate (item 22)

Install the inner guard support plate and spacer plate to the inner guard panel, loosely install six pop rivets (item 24) to hold the support plate in position. Using a felt tip pen or the 5.0mm drill bit mark the two lower mounting hole positions onto the inner guard panel.

Remove the pop rivets, inner guard support plate and spacer plate.

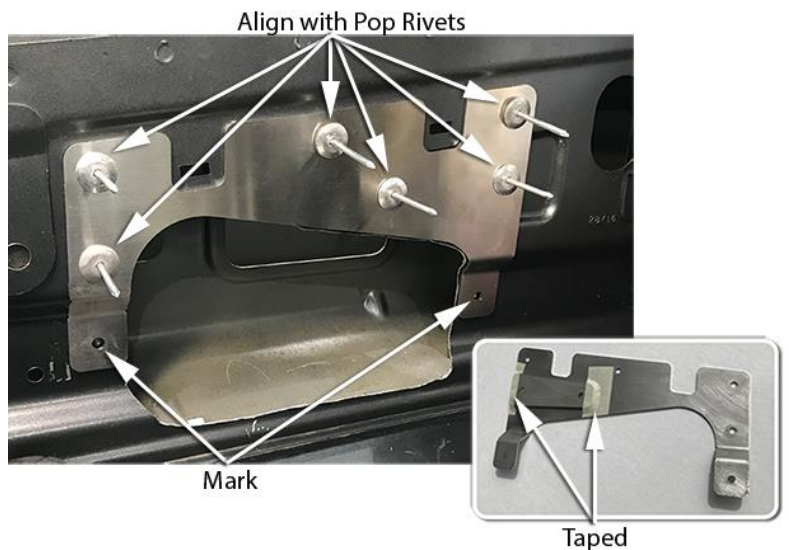

13

Drill a pilot hole at each of the two marked hole positions, drill the two hole positions to 5.0mm diameter.

Deburr all holes and cut section of the inner guard panel.

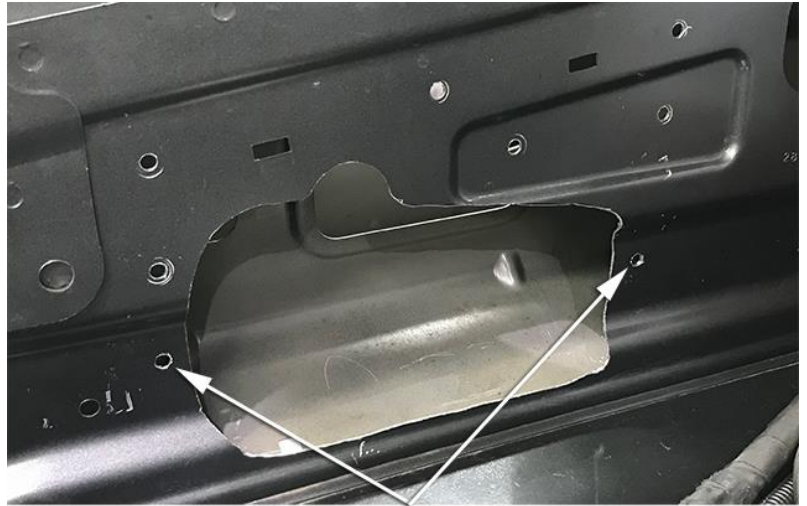

Drill 5mm Dia

14

Install the internal inner guard reinforcement plate (item 25) to the internal inner guard panel, align to the 6.5mm hole and to the large oval shaped hole in the internal inner guard panel, use a M6 button head bolt (item 26) to locate the reinforcement plate.

With the reinforcement plate correctly aligned mark the cut-out onto the internal inner guard panel using a felt tip pen, using a long series 6.0mm drill bit (160mm long approx.) drill the five holes shown.

Remove the M6 Button Head Bolt and the reinforcement plate.

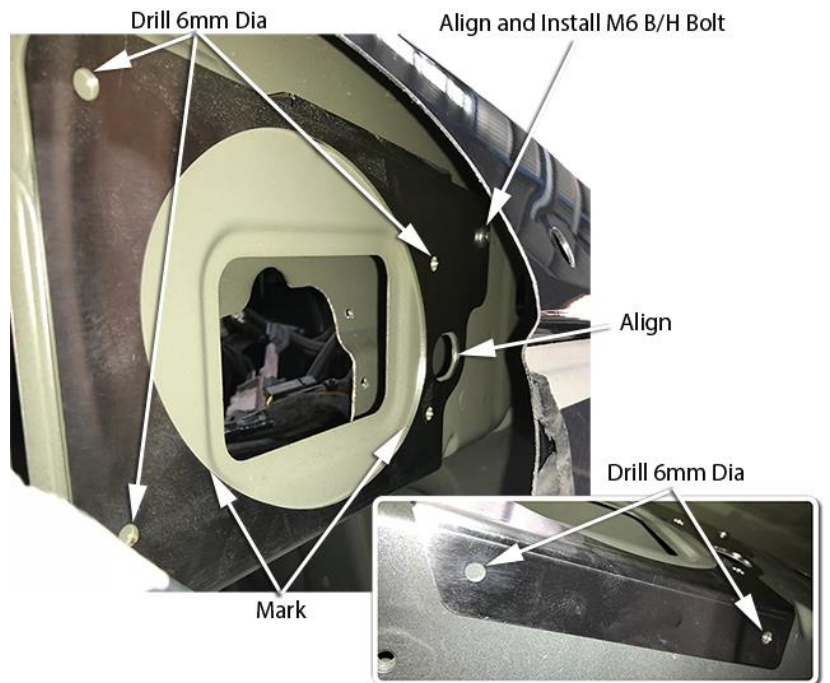

Using a 6.5mm long series drill bit, re-drill the five holes to 6.5mm diameter.

Drill a 10mm diameter starting hole for the body saw blade as shown.

Using the body saw, cut the hole in the internal inner guard panel (cutting on the outside of the line), the hole will need to be cut from either side of the panel through the hole in the main guard panel and inner guard panel.

Deburr all holes and cut section of the internal inner guard panel.



Align the internal inner guard panel template (item 33) to the two 6.5mm holes and the large oval shaped hole in the internal inner guard panel, use two M6 button head bolts (item 26) to correctly locate the template, using a felt tip pen mark the hole position onto the internal inner guard panel.

Remove the template.

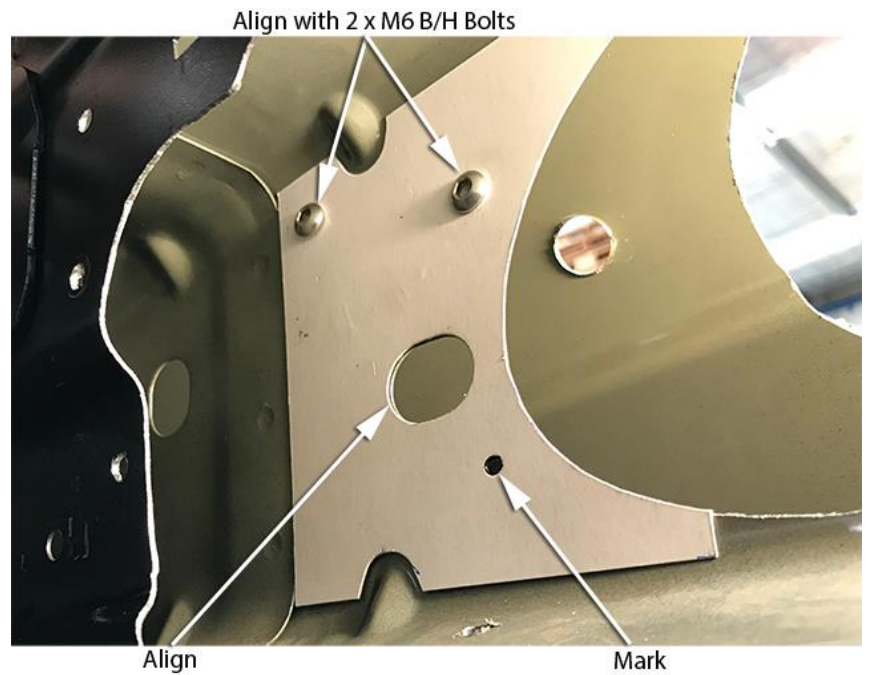



17

Drill a pilot hole at marked hole position, using the long series 6.5mm drill bit, drill the hole position to 6.5mm diameter.

Deburr the hole.

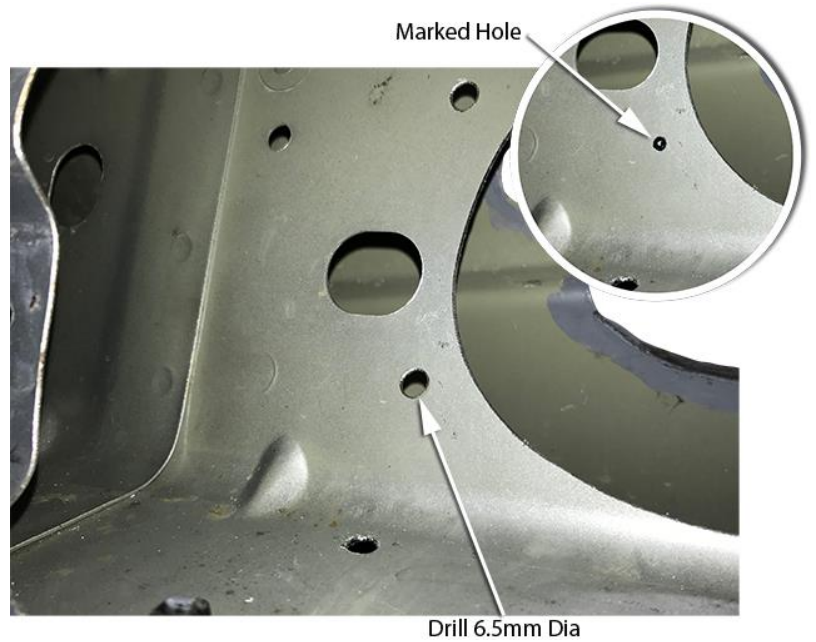

18

Install the upper mounting bracket (item 3) to the snorkel body (item 1) with hex bolts (item 4).

Apply loctite 243 to each of the five stainless steel mounting studs (item 7) and install the studs finger tight into the snorkel body (item 1) mounting inserts.

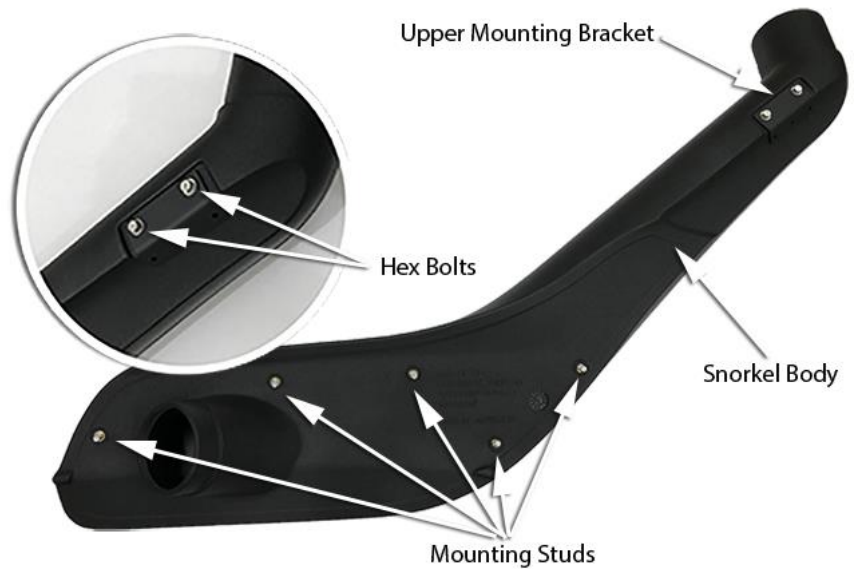

19

Place a strip of masking tape along the A-pillar panel.

Carefully install the snorkel body (item 1) to the guard panel.

With the snorkel body correctly positioned, mark the position of the upper mounting bracket onto the masking tape as shown.



Remove the snorkel body (item 1) from the vehicle and remove the upper mounting bracket (item 3) from the snorkel body.

Position the upper mounting bracket onto the A-pillar and align the bracket to the marked bracket position on the masking tape.

With the bracket correctly positioned mark the three mounting hole positions with a felt tip pen.

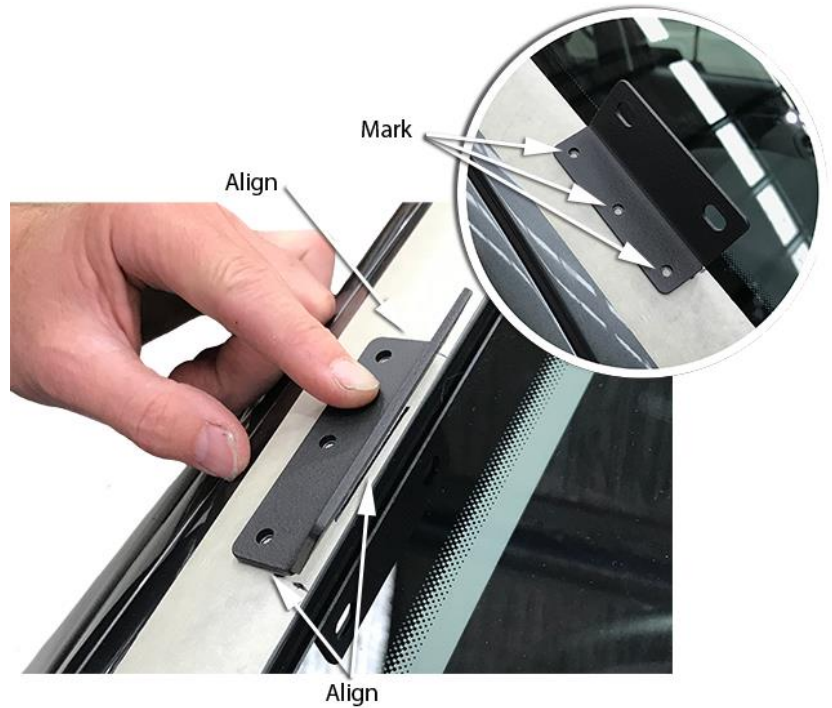

Drill a pilot hole at each of the three marked hole positions.

Drill each hole position to 8mm diameter with a step drill or 8mm drill bit.

Deburr and paint holes to prevent rust.

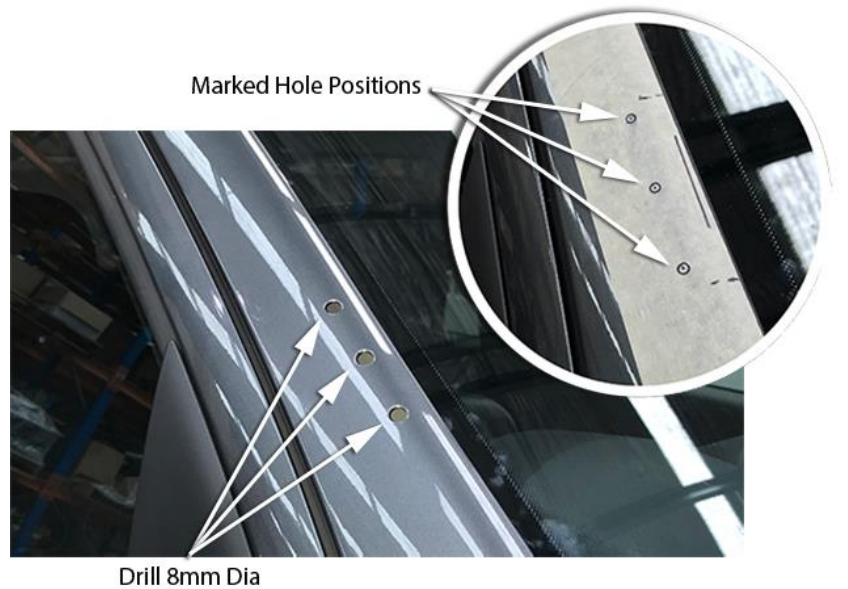

Install the plastic inserts (item 6) into the 8mm diameter holes in the A-pillar.

Secure the upper mounting bracket (item 3) to the A-pillar with three stainless steel self-tapping screws (item 5).

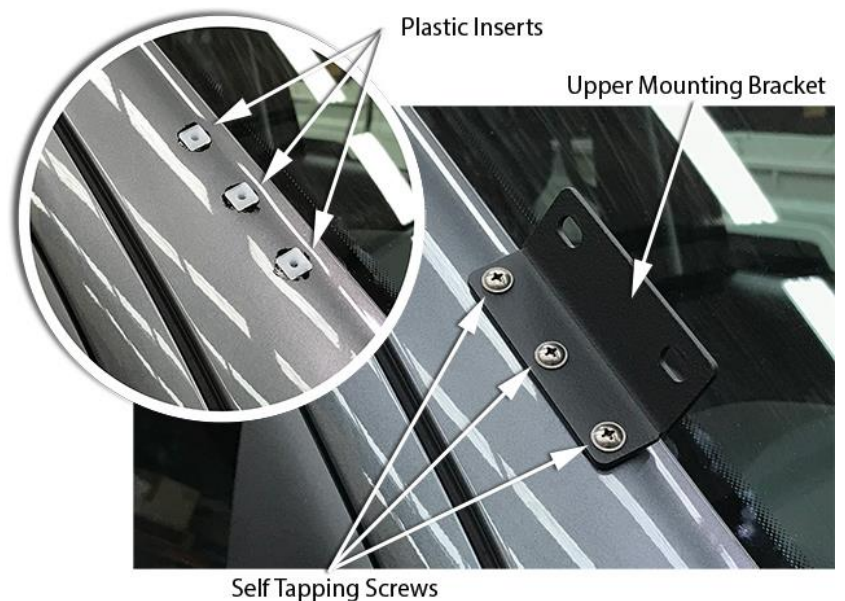

Deburr all drilled and cut panels (main guard panel, inner guard panel & internal inner guard panel).  
 Using compressed air, thoroughly clean and remove all metal swarf and metal filings from the inner guard and engine bay areas.  
 Clean and paint all bare metal surfaces.

Apply a generous amount of Sikaflex adhesive sealant to the internal inner guard reinforcement plate (item 25).



Install the reinforcement plate with adhesive sealant applied to the internal inner guard panel, install all seven M6 button head bolts (item 26) and secure the reinforcement plate to the internal inner guard panel with M6 body washers (item 27) and M6 nyloc nuts (item 28).

Clean-up any excess sealant to ensure a neat finish.

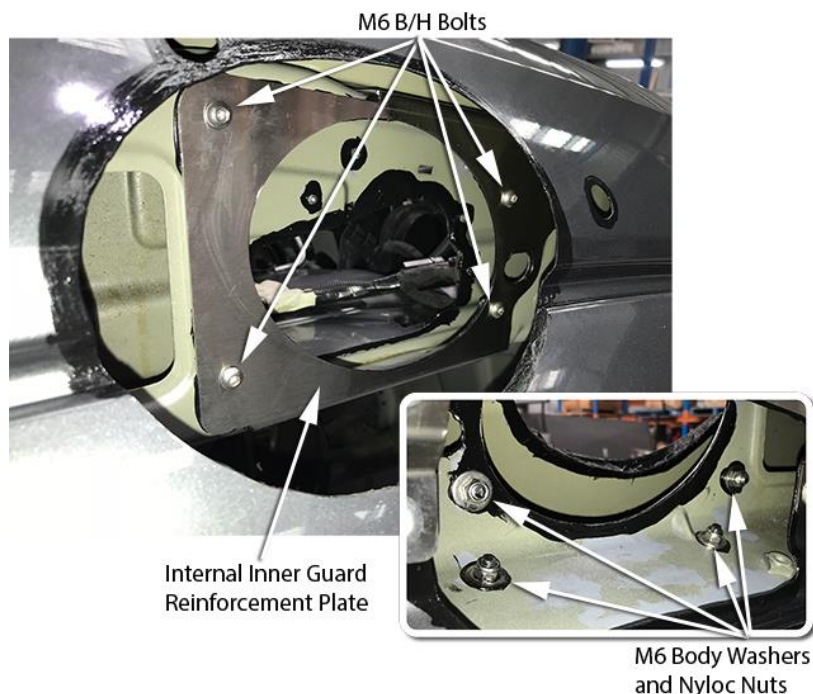

26

Apply a smear of Sikaflex adhesive sealant to the inner guard support spacer plate (item 23), align the spacer to the two holes in the inner guard support plate and press down firmly.



27

Apply a generous amount of Sikaflex adhesive sealant to the inner guard support plate (item 22) and spacer plate (item 23).

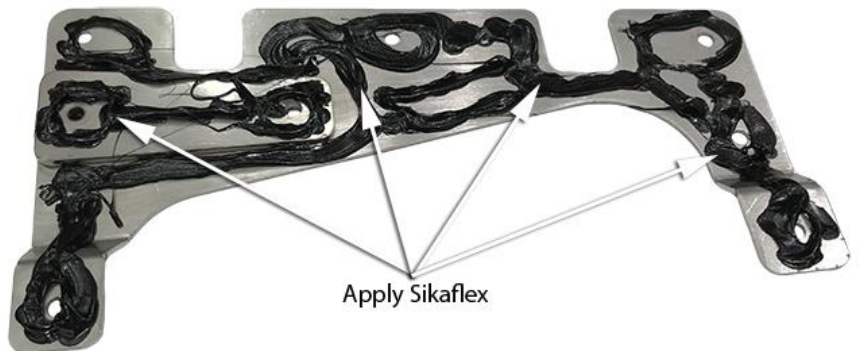

28

Install the inner guard support plate and spacer plate with Sikaflex adhesive sealant applied to the inner guard panel, install all eight pop rivets, using a pop rivet gun secure the inner guard support plate and spacer to the inner guard panel.

Clean-up any excess sealant to ensure a neat finish.

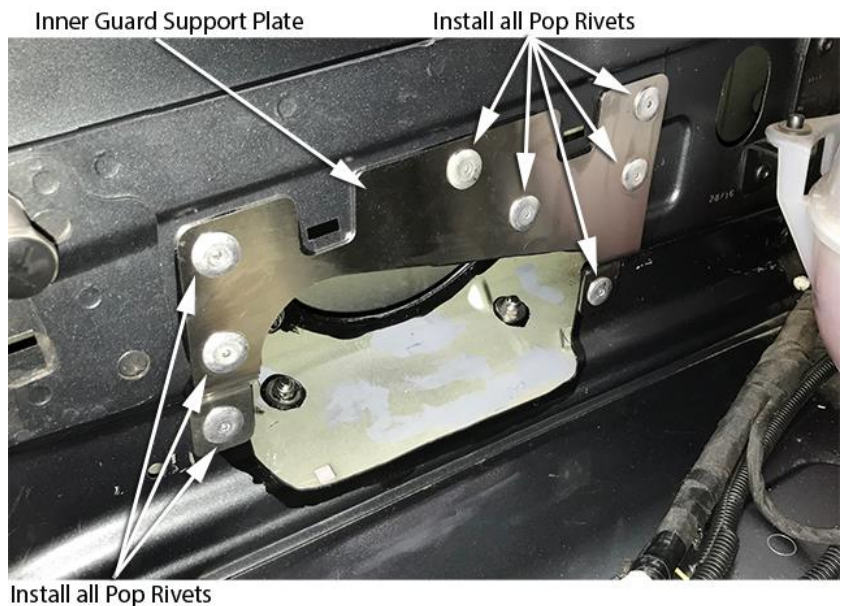

Apply Sikaflex adhesive sealant to the gap between the flare and guard panel.

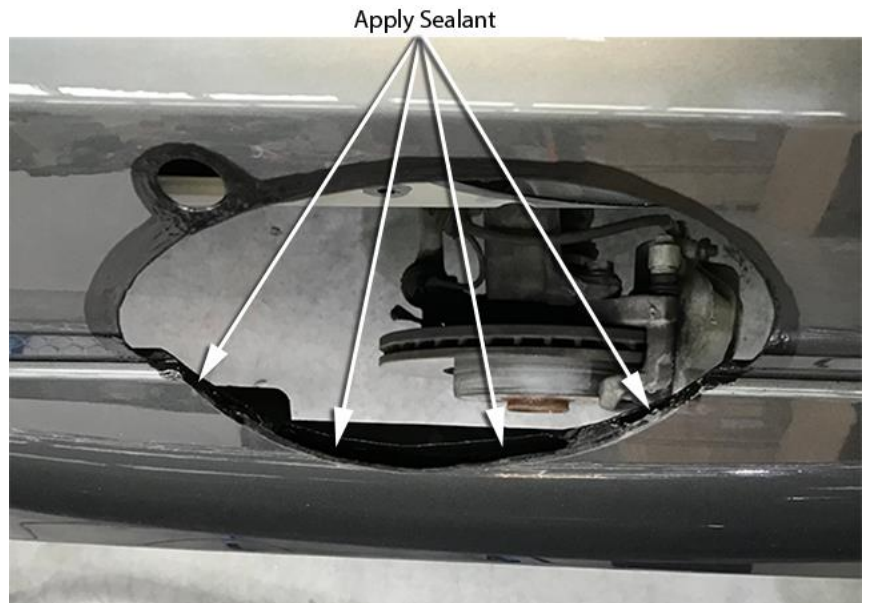

Measure down 25mm from under the air cleaner base top shoulder and mark the seven air cleaner base top ribs and the one lower rib as shown.

Use a grinder or sharp knife, remove the sections of the ribs from the side of the air cleaner base.

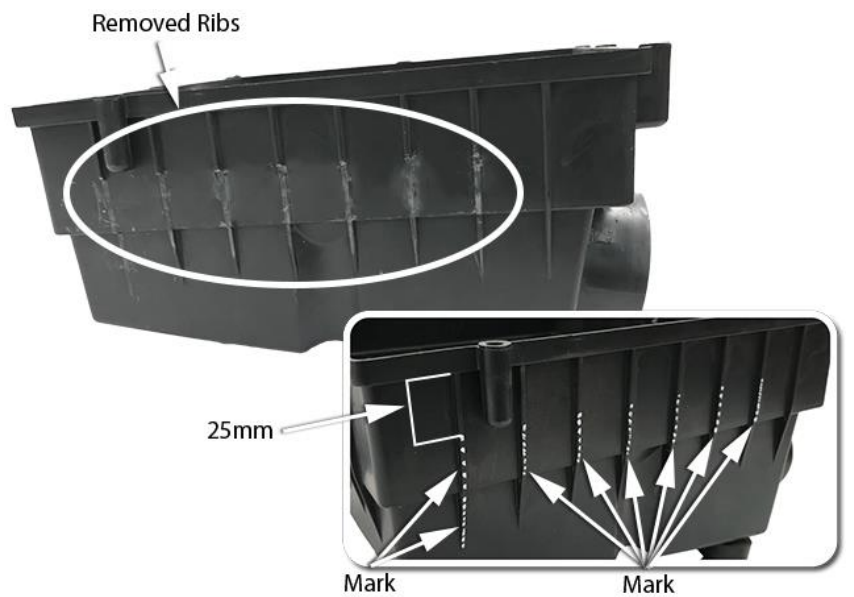

Place a strip of masking tape along the side face of the air cleaner base.

Align the air cleaner inlet template (item 29) onto the side of the air cleaner base as shown.

Mark all four hole positions and a cutting line under the template with a fine felt tip pen or paint marker pen.

Remove the template.

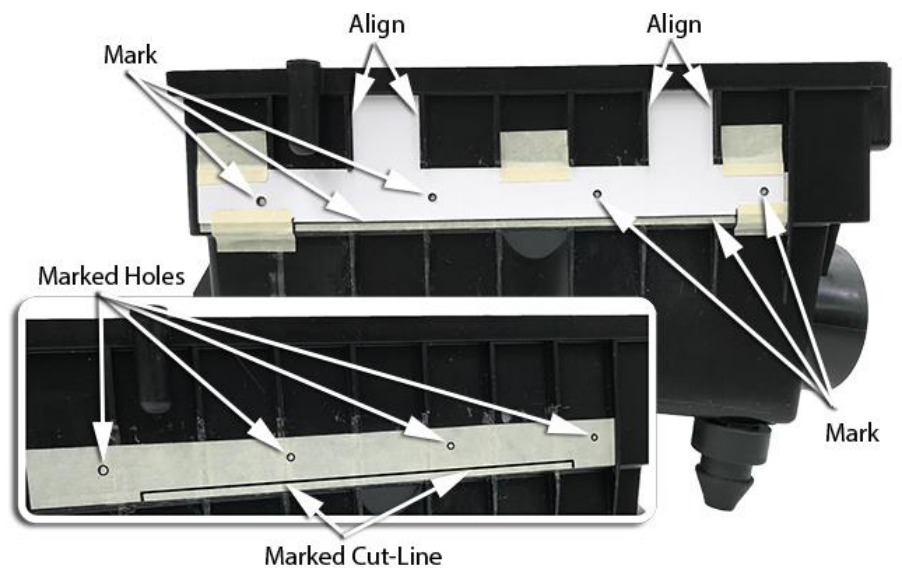

Place a strip of masking tape along the side lower face of the air cleaner base.

Align the air cleaner inlet template (item 30) onto the side of the air cleaner base as shown.

Mark the cut-out section and the five hole positions with a fine felt tip pen or paint marker pen.

Remove the template.

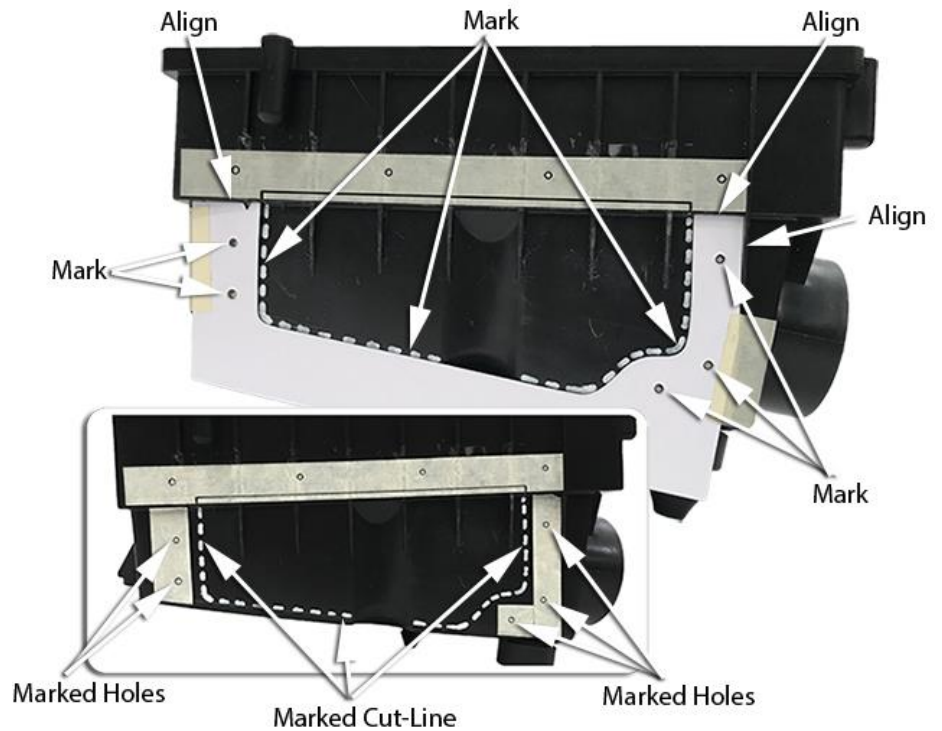

Align the lower air cleaner inlet template (item 31) onto the underside of the air cleaner base as shown.

Mark the four hole positions and cut-out section with a fine felt tip pen or paint marker pen.

Remove the template.

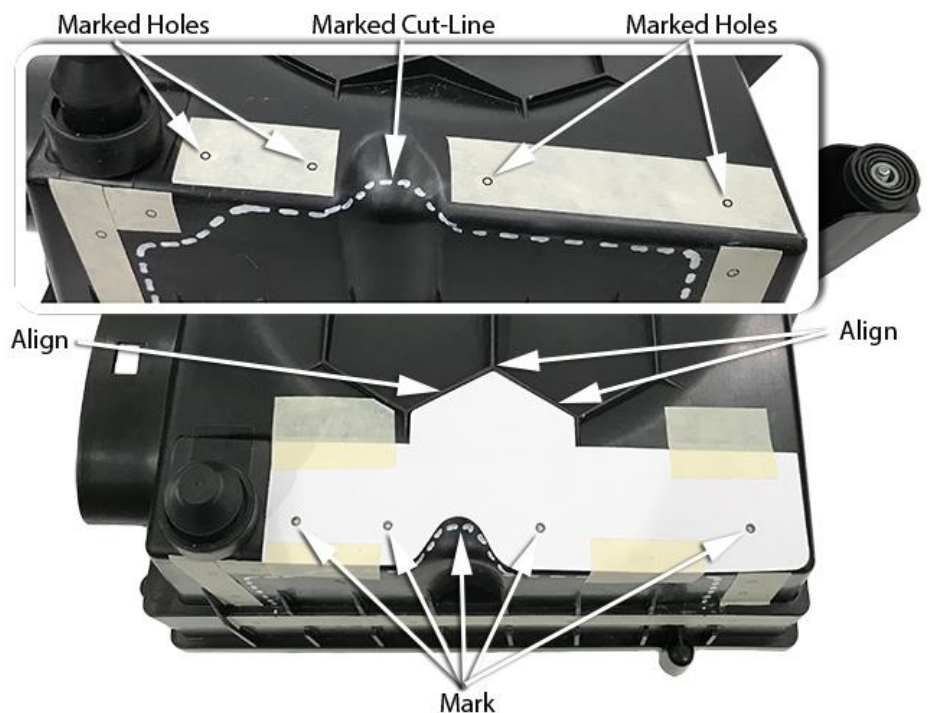

Using a 4.0mm drill bit, drill all 13 marked hole positions.

Using the body saw cut the new air inlet hole as marked from the templates in steps 31,32 & 33.

Use a file to clean-up the cut section, deburr all drilled holes.

A small section of an internal rib needs to be removed from the inside of the air cleaner base, using a sharp knife or grinder, remove the rib as shown from around the drilled hole.

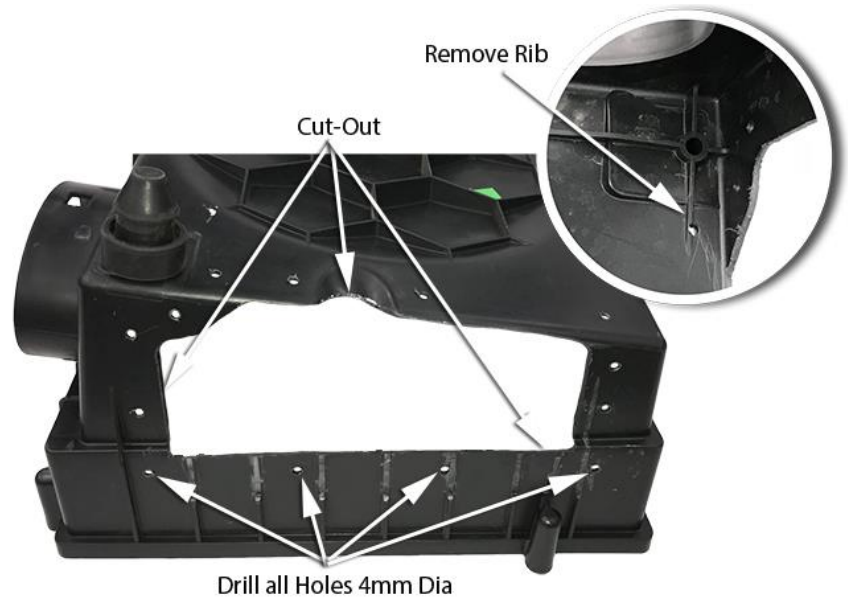

The four ribs around the air cleaner inlet snout must be completely removed, using a body saw, hacksaw blade or sharp knife remove the 4 ribs from around the air cleaner inlet snout as shown.

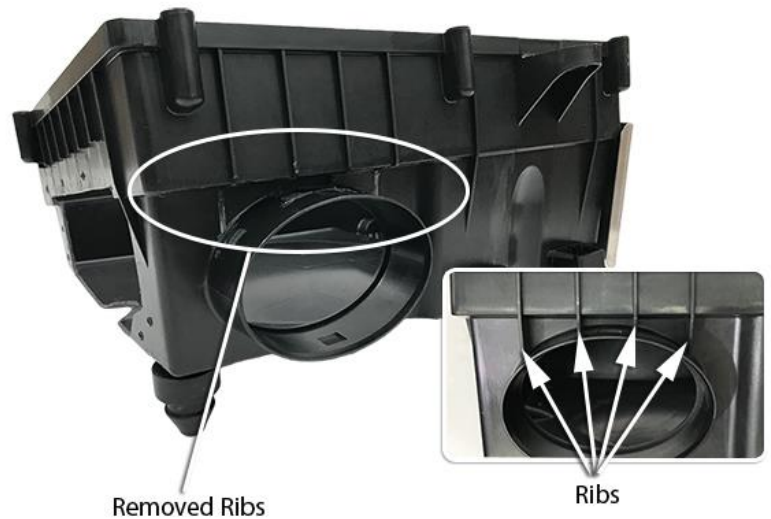

Install the air inlet blank-off cap (item 18) over the air cleaner inlet snout, with the blank-off cap correctly installed secure with a 70/90mm hose clamp (item 19), ensure the hose clamp is positioned to the rear edge of the blank-off cap.

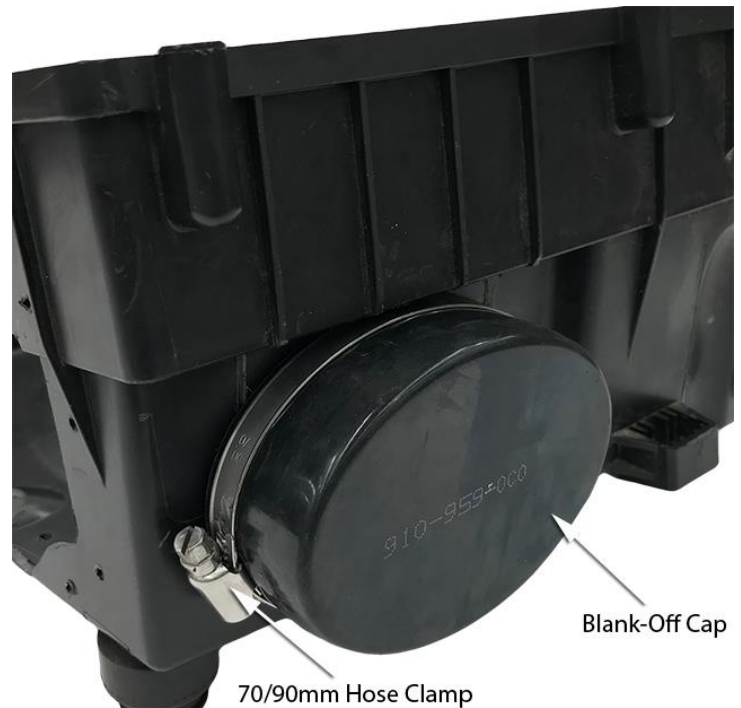

Apply adhesive sealant to the mating surfaces of the air entry hose.

Install the air entry hose onto the air cleaner base, install the upper, sides and lower clamping plates (item's 11, 12, 13 & 14) to the hose, install the air filter element support plate (item 15), install all thirteen pop rivets (item 16).

**Note: the orientation of the four lower pop rivets**, install a 4mm body washer (item 17) onto each of the four lower pop rivets as shown.

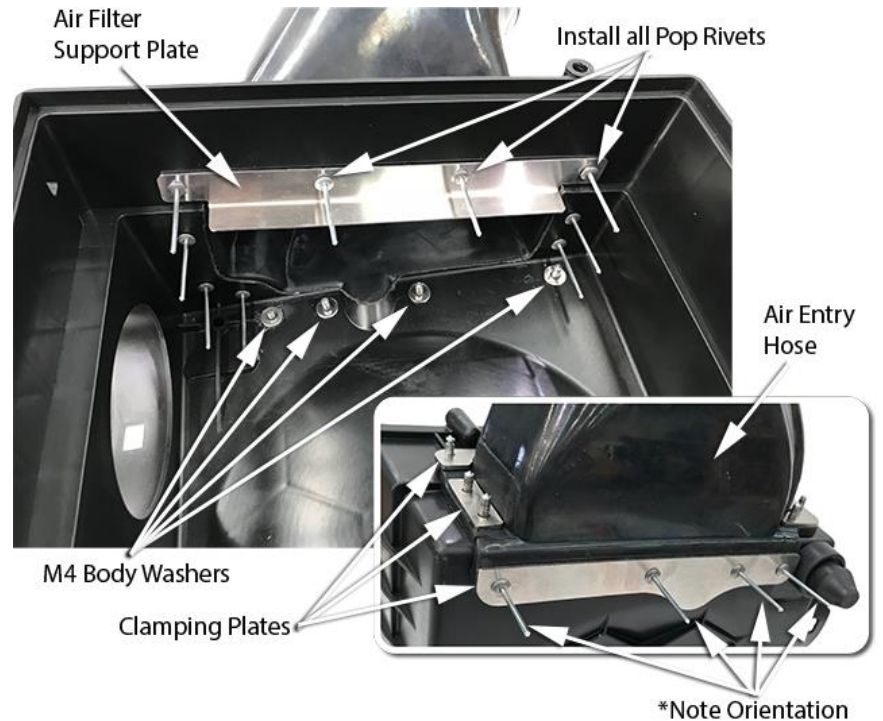



With all thirteen pop rivets installed, use the pop rivet gun to secure the pop rivets.  
Clean-up any excess sealant to ensure a neat finish.

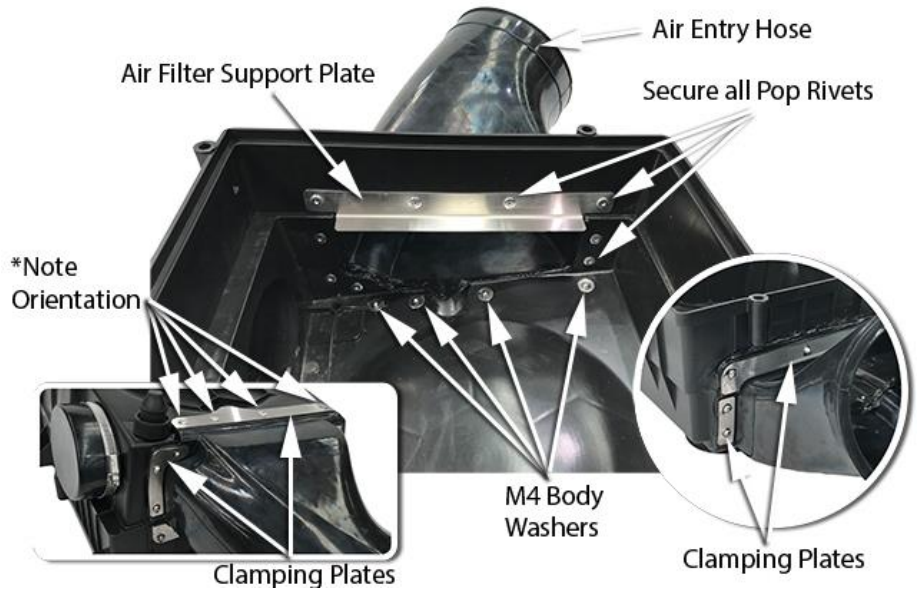

Install the coolant bypass hose into its mounts and position the wiring harness along the inner guard panel as shown.  
Reinstall the inner guard liner mounting clip removed in step 8.

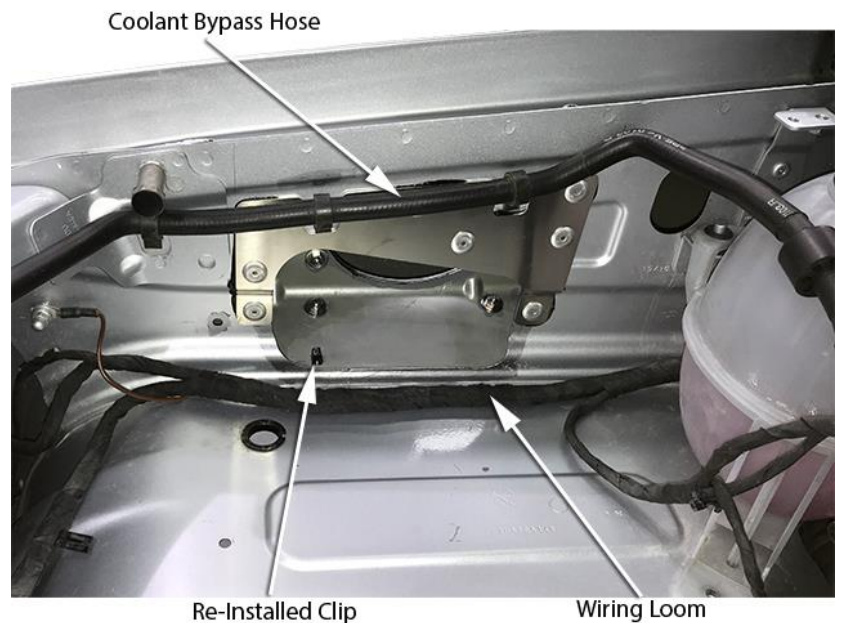

**INSTALLER OPTION:**

The air cleaner housing contains a drain valve as shown.  
The serviceability of the drain valve must be checked by the installer.  
If necessary the drain valve should be replaced or sealed with sealant by the installer, to prevent water from entering the air cleaner housing.



The end of the air entry hose (item 10) must be squashed inwards and taped to hold in position as shown.

**Note: it is critical the hose is taped the way shown in the photo, for installation purposes.**



Tape Air Entry Hose

With the hose correctly taped, spray lubricant over the outside of the hose.

Install the air cleaner assembly into position, guiding the air entry hose through the holes in the inner guard panels, ensure the two air cleaner base mounting pins locate correctly into the mounting holes and fasten the rear mounting bolt.

Remove the tape.

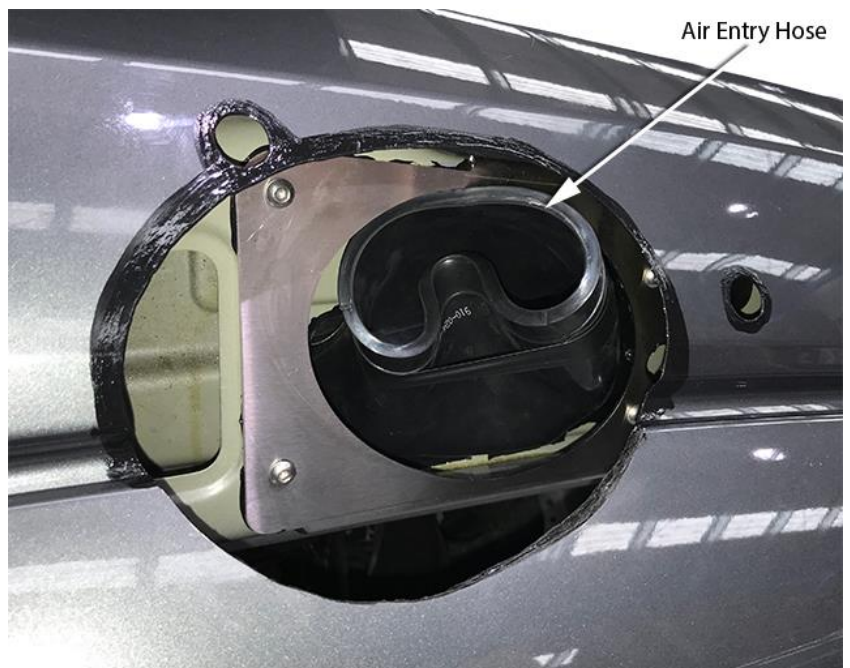

Air Entry Hose

Loosely install the 90/110mm hose clamp (item 20) onto the air entry hose (item 10).

Carefully install the snorkel body (item 1) to the guard panel, guiding the snorkel body outlet snout into the air entry hose (item 10), align the snorkel body to the guard panel and upper mounting bracket.

When correctly aligned, fasten the snorkel body to the guard panel with body washers (item 8) and nyloc nuts (item 9).

Fasten the snorkel body to the upper mounting bracket with hex bolts (item 4).

Ensure the air entry hose is correctly installed onto the snorkel body outlet snout and tighten the 90/110mm hose clamp (item 20).



Install the washer bottle assembly, washer bottle filler neck, side indicator and connect wiring, install the air cleaner element and air cleaner lid and connect wiring and hoses. Top up the washer bottle with washer fluid and check washer operation, install the inner guard liner, mud flap and any other items that may have been removed during the snorkel installation process.

45

Install the black hose clamp (item 21) loosely to the base of the air ram assembly (item 2).

Install the air ram assembly onto the snorkel body.

Align the air ram and tighten the black hose clamp (item 21).



46

**N.B: It is the installer's responsibility to ensure that all connections are water tight.**