



SS1135HF SAFARI V-SPEC SNORKEL

Jeep KJ Cherokee CRDI4
2.8Litre-I4 Diesel Engine



23/2/2010

Parts List

ITEM	PART NO	DESCRIPTION	QTY
1	965-133-000	BODY - SNORKEL (SS1130HF)	1
2	000-135-800	3 ½" AIR RAM ASSEMBLY	1
3	965-032-000	BRACKET - UPPER MOUNTING	1
4	000-002-100	BOLT - HEX - 6mm x 1.0 x 14mm (SEMS)	2
5	000-958-550	POP RIVET - 4.8mm x 18mm	6
6	000-110	STUD - S/S 8mm x 1.25 x 25mm O/L	4
7	000-311-300	WASHER - BODY - 8.5mm x 32mm - S/S	4
8	000-205-300	NUT - NYLOC - 8mm x 1.25mm - S/S	4
9	965-024-000	CONNECTOR - AIR INTAKE	1
10	965-025-200	PLATE - AIR INTAKE CONNECTOR	1
11	000-909	CLAMP - HOSE - 80/100mm	1
12	965-025-300	PLATE - BLANK-OFF (AIR CLEANER INLET)	1
13	000-958-450	TRIFOLD RIVET - 4.8mm x 21mm	4
14	000-951-550	SCREW - S/T - 4.8mm x 16mm	1
15	000-958-600	POP RIVET - PLASTIC	7
16	965-217-000	TEMPLATE - ENGINE BAY	1
17	965-217-200	TEMPLATE - INNER FENDER	1
18	965-017-000	TEMPLATE - FENDER PANEL (FRONT)	1
19	965-017-200	TEMPLATE - FENDER PANEL (REAR)	1
20	000-914/B	CLAMP - HOSE - SIZE 56 (BLACK)	1

Installation Guide

Fitment to:

- Right Hand Side

Fitting Time:

- 240 min

Special Tools:

- Air Body Saw (Reciprocating)
- Step Drill
- Pop-Rivet Gun
- 90 deg drill
- Hole Saws - 60mm, 76mm & 92mm
- Drills - 3.2mm, 5mm, 5.5mm
- Touch-up Paint
- Prep Wash
- Masking Tape
- Sikaflex 227 (adhesive sealant)
- Loctite 243 (thread lock)

Prior to commencing the installation, it is the installer's responsibility to verify that all components and particularly the templates (Items 16, 17, 18 & 19) are correct.

1

Remove the fender flare and sill moulding trim (if fitted) in accordance with the factory service manual.

If the sill moulding trim is fitted, the retaining clips may be damaged when removing. It is advisable to have replacement clips on hand.

Remove



2

Remove the air cleaner assembly.

Cover the turbocharger air inlet hose to prevent foreign particles from entering.

Remove and discard the air cleaner inlet duct.

Cover Inlet

Remove & Discard



- 3** Align the templates (Items 18 & 19) with the fender flare clip holes and secure the templates in place with masking tape.

Use a felt tip pen to mark the two hole positions on the rear template (Item 19) and the required cut out area and four hole positions on the front template (Item 18).

Remove the templates.

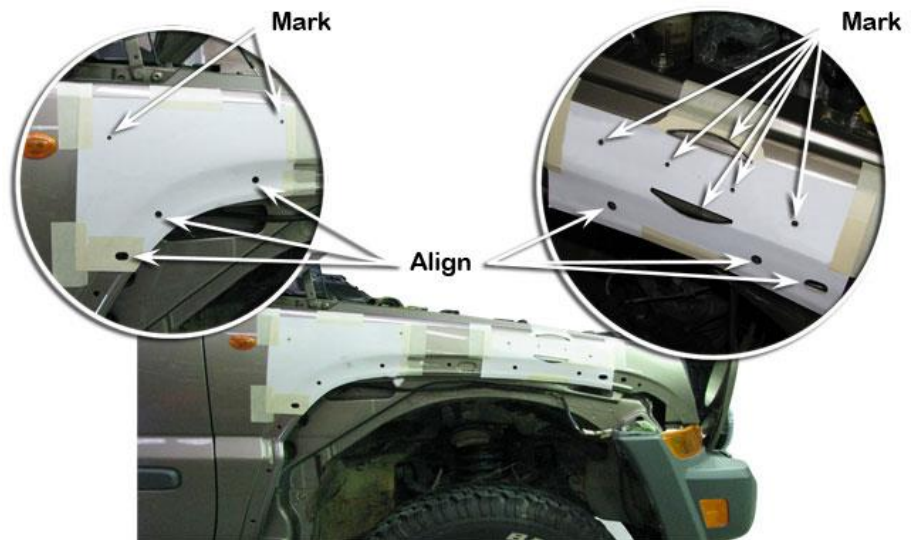

- 4** Drill pilot holes for the six marked hole positions.

Use a step drill to drill the four mounting hole positions to 16mm diameter.

Use a 60mm diameter hole saw to drill the two holes shown for the snorkel body outlet

Use an air body saw to remove the marked area of the fender panel and smooth with a fine file.

De burr and paint all the exposed metal surfaces to prevent rust.



- 5** Remove the fender panel in accordance with the factory service manual.

Hint: Before removing the fender panel retaining bolts, mark around each washer to allow for easier panel realignment when reinstalling the fender panel.



6

Align the inner fender template (Item 17) to the edge of the panel as shown and secure in place with bolts and masking tape.

Use a felt tip pen to mark the hole positions and the required panel area which needs to be removed.

Remove the template.

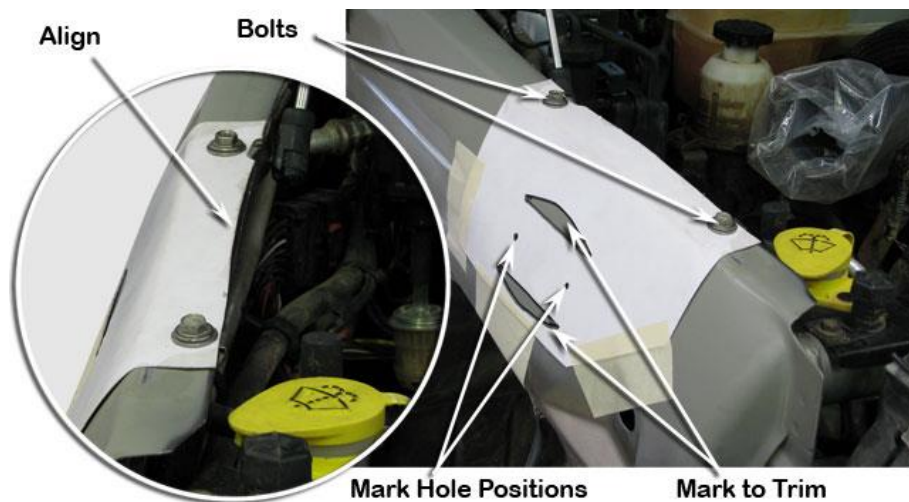

7

Drill a pilot hole for the two marked hole positions.

Use a 60mm diameter hole saw to drill the two marked hole positions.

Use an air body saw to remove the marked area of the panel and smooth with a fine file.

De burr and paint all the exposed metal surfaces to prevent rust.

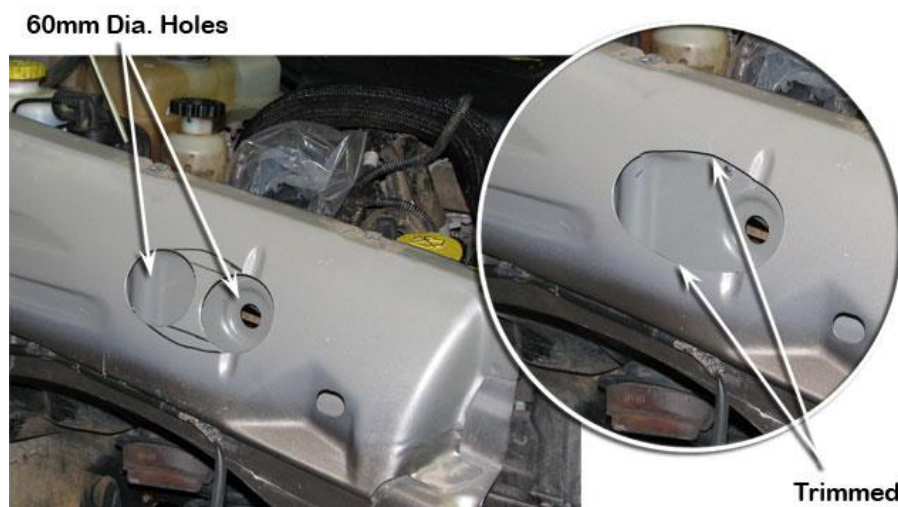

8

If an engine bay lamp switch is fitted, remove the switch and mounting bracket assembly from the engine bay panel.

Remove the two nuts shown and position the engine bay template (Item 16) over the two studs. Align with the hole position shown and secure the template in place with the two nuts and masking tape.

Use a felt tip pen to mark the hole positions and the required panel area which needs to be removed.

Remove the template and drill a pilot hole for the two marked hole positions.

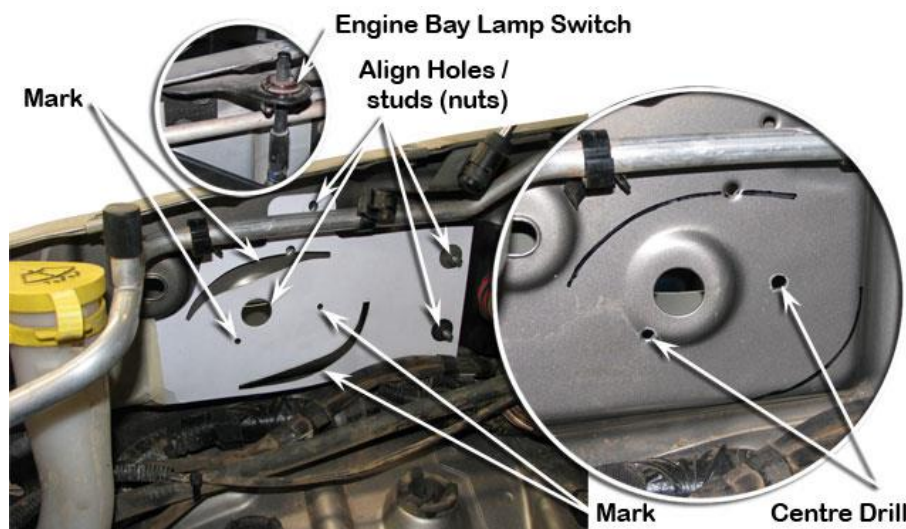

9

Use a 76mm diameter hole saw and drill the two hole positions.

Use an air body saw to remove the marked area of the engine bay panel and smooth with a fine file.

De burr and paint all the exposed metal surfaces to prevent rust.



10

If an engine bay lamp switch was fitted, reinstall the switch assembly and mark the section of the mounting bracket that needs to be removed.

Remove the switch assembly.

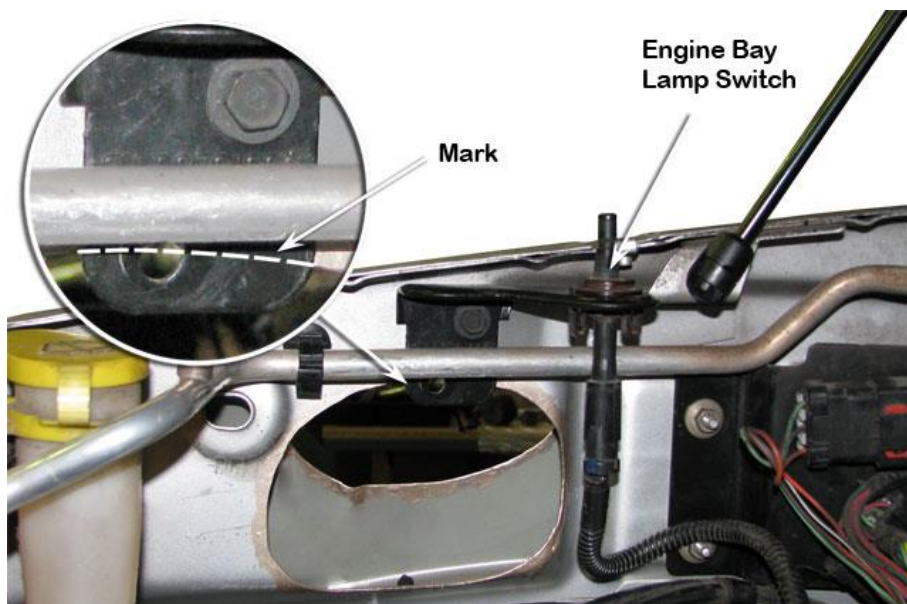

11

Cut the switch mounting bracket along the marked curve and drill a 5.5mm hole into the bracket as shown.

Install the switch assembly and drill a 3.2mm diameter hole through the engine bay panel as shown.

Install a 4.8mm x 16mm self tapping screw (Item 14) shown.

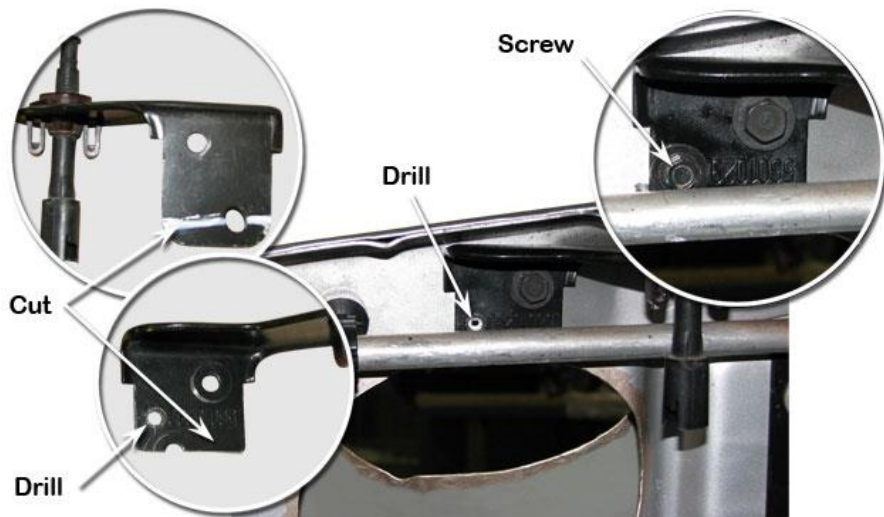

12

Reinstall the fender panel in accordance with the factory service manual.

Hint: Use the previously marked washer positions to align the fender panel.



Install Panel

13

Apply Loctite 243 to each of the stainless steel mounting studs (Item 6) and install the studs finger tight into the inserts in the snorkel body (Item 1).

Install the upper mounting bracket (Item 3) to the snorkel body (Item 1) and secure with hex bolts (Item 4).

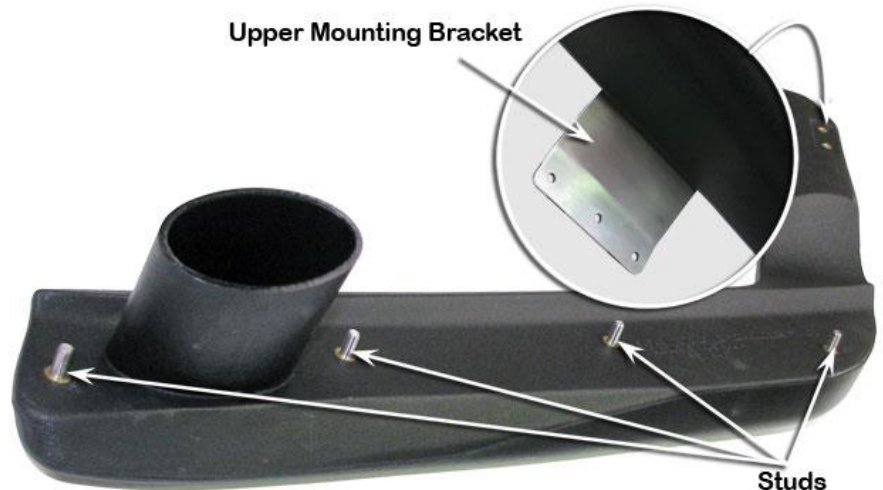

14

Remove the a-pillar rubber weather seal and molding. Place a strip of masking tape along the a-pillar.

Install the snorkel body onto the fender panel.

Align the snorkel body to the fender panel and the upper mounting bracket to the a-pillar.

Ensure that there is 3mm-5mm clearance between the snorkel body and the door frame in the closed position.

The centre hole of the upper mounting bracket may line up with the existing molding retaining screw hole as shown. If not, this hole position must be marked.

Mark the outline and the mounting hole positions of the upper mounting bracket.

Remove the snorkel body and extend the outline marked lines as shown.

Masking Tape

Check Clearance



Mark Holes & Outline

Extend Lines



- 15** Place the a-pillar molding back onto the a-pillar and mark the extended lines from the top and bottom edges of the upper mounting bracket onto the molding.

Remove the a-pillar molding and drill the three marked upper mounting bracket hole positions on the a-pillar with a 5mm diameter drill.

De burr and paint all exposed metal surfaces to prevent rust.



- 16** Increase the length of the marked cut-out by 3mm at each end for additional clearance. Mark the depth of the cut-out to 28mm.

Use an air body saw to cut the marked piece from the a-pillar molding and use a fine file to smooth the cut edges.

Reinstall the a-pillar molding.

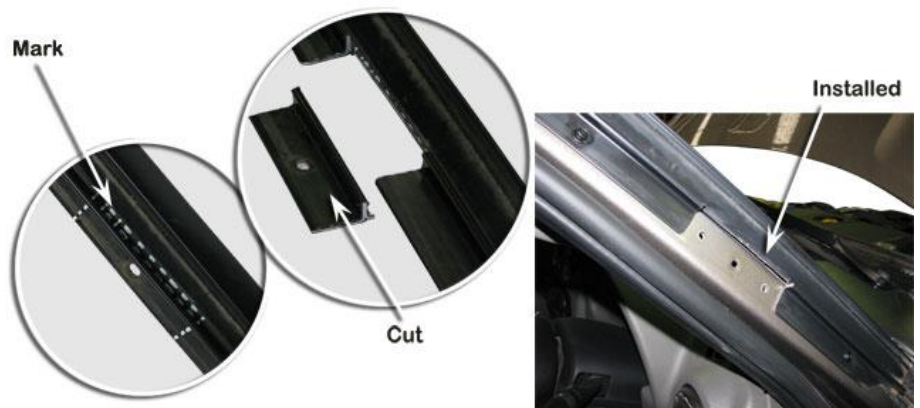

- 17** Apply adhesive sealant to the mounting surface of the upper mounting bracket (Item 3).

Install the upper mounting bracket (Item 3) to the a-pillar and insert three 4.8mm x 18mm pop rivets (Item 5). Use a pop rivet gun to secure upper mounting bracket to the a-pillar.

Install the a-pillar rubber weather strip.



18 Place the air cleaner housing base upside down onto a flat surface and match the orientation as shown.

Measure 84mm up and 9mm in from the centre of the 3rd rib from the left.

Mark the hole centre position on the air cleaner housing base.

Drill a pilot hole and then a 92mm diameter hole at the marked hole position.

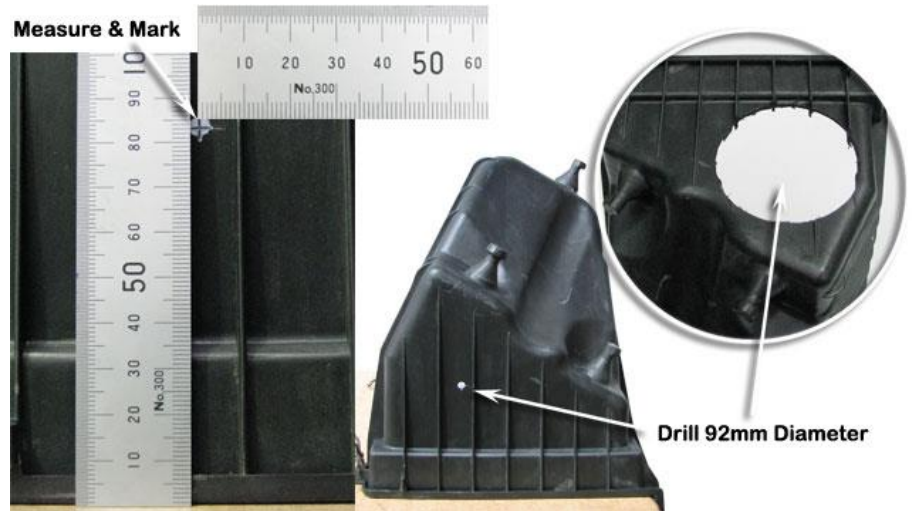

19

Use a sharp blade to remove the internal and external ribs shown around the 92mm hole drilled previously in the air cleaner base.

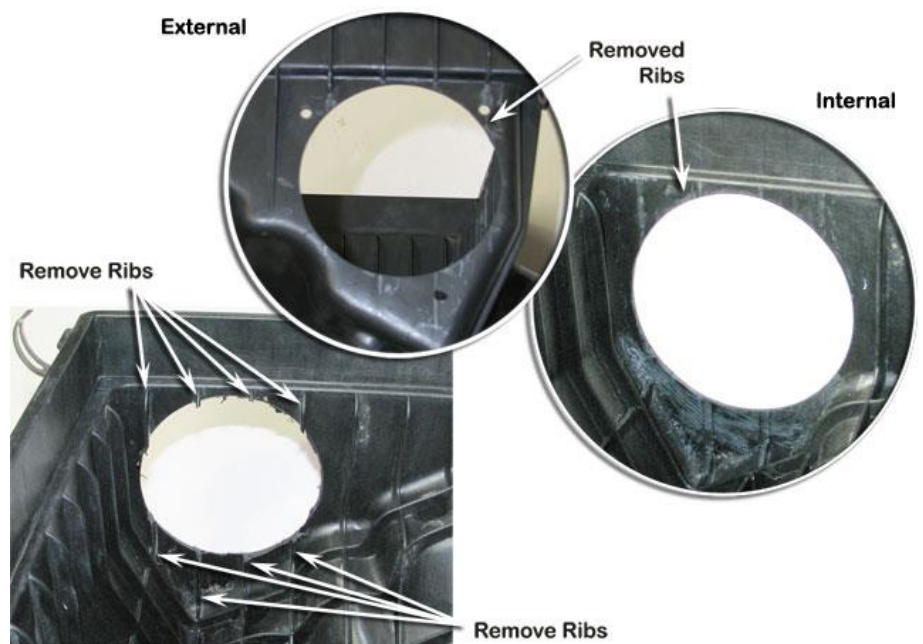

20 Install the air intake connector (Item 9) through the 92mm hole drilled previously.

When correctly aligned, mark the three flange hole positions.

Remove the air intake connector (Item 9).

Use a 90 deg drill, drill a pilot hole through each of the three marked hole positions.

Drill the three holes to 5mm diameter.

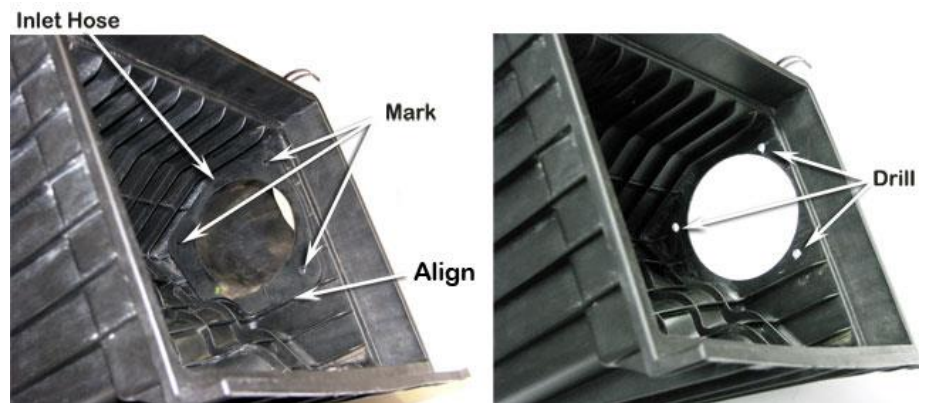

21 Place the air cleaner housing base upside down onto a flat surface and match the orientation as shown.

Measure 110mm up and mark the five ribs shown.

Use a sharp blade to trim the ribs and remove the rib sections as shown.

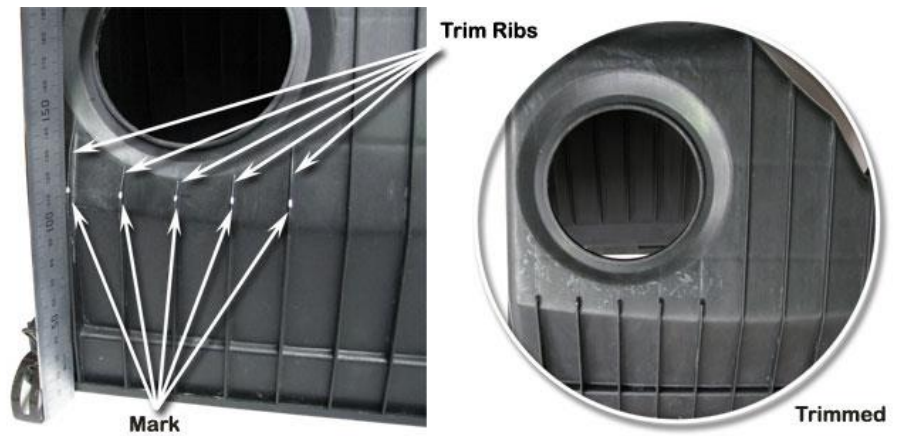

22 Place the blanking plate (Item 12) over the air cleaner inlet hole. Note that the blanking plate must be orientated with the hole positions as shown.

Mark the blanking plate mounting hole positions. Remove the blanking plate and drill the marked hole positions with a 5mm drill.

Apply adhesive sealant around the perimeter of the air cleaner inlet hole, install the blanking plate and secure in place with four 4.8mm x 21mm trifold-rivets (Item 13).



23 Apply adhesive sealant to the air intake connector flange (Item 9).

Install the air intake connector (Item 9) through the 92mm hole and align with the 5mm diameter mounting holes.

Install the air intake connector plate (Item 10). Insert three pop rivets (Item 5).

With all pop-rivets in position, install the lower pop-rivet first and then the remaining two pop-rivets.



24 INSTALLERS OPTION

The air cleaner housing may have a number of drain holes as shown. It is up to the installer to determine whether the holes should all be totally sealed off to prevent any water from entering the air intake system when immersed in deep water. Use adhesive sealant to seal the air cleaner housing base drain holes.

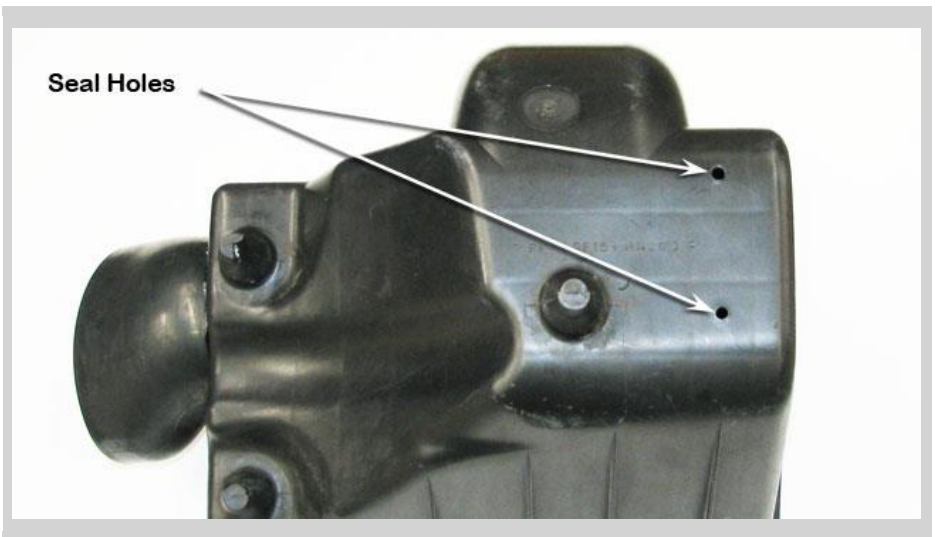

25 Install a 80/100mm hose clamp (Item 11) loosely over the air intake connector - Note the hose clamp orientation shown. Apply a small amount of rubber lubricant to the inner surface of the air intake connector and to each of the three air cleaner housing mounting posts. Install the air cleaner base assembly back into the engine bay. Check for adequate clearance between the air intake connector and the hole through the panel - trim panel if required.

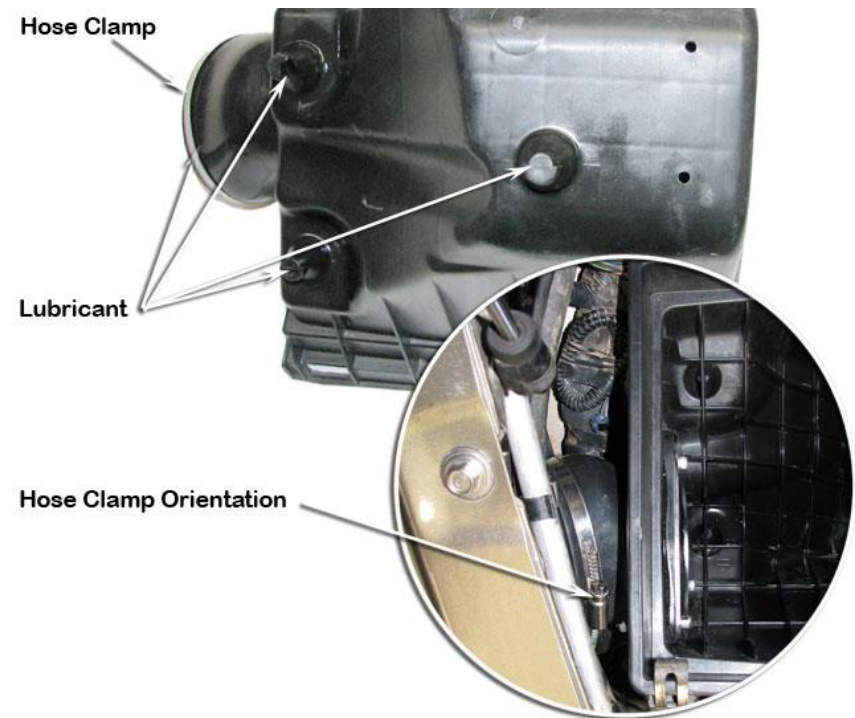

26 Install the snorkel body (Item 1) onto the fender panel whilst guiding the snorkel body outlet into the air intake connector (Item 9). Align the snorkel body to the upper mounting bracket and fender panel. Check for adequate clearance to the corner of the hood when opening and closing. When correctly aligned, fasten the snorkel body to the fender panel with body washers (Item 7) and Nyloc nuts (Item 8). Fasten the snorkel body to the upper mounting bracket with hex bolts (Item 4).



26

Tighten the 80/100mm hose clamp (Item 11) over the air intake connector.

Reinstall the air filter element, air cleaner housing top and connect sensor plugs.

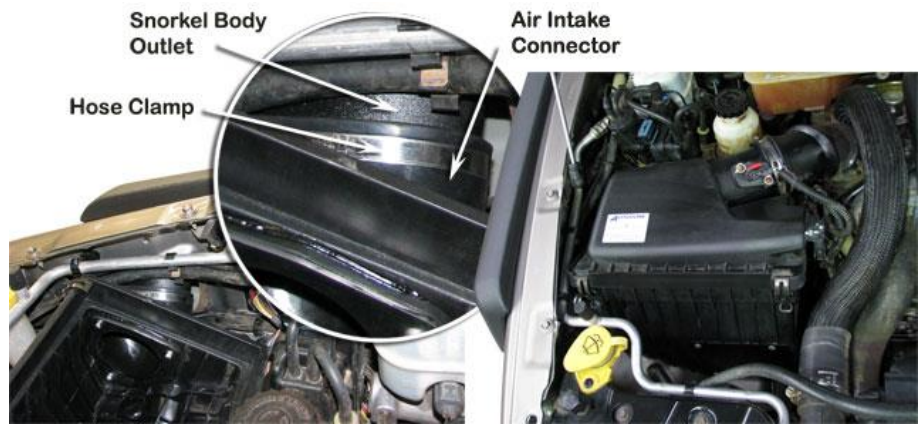

26 Reconnect the fender indicator lamp wiring connector.

Reinstall the sill molding trim (if fitted to the vehicle).

Reinstall the fender flare ensuring that all clips are correctly located into the fender panel mounting holes.

Reinstall the fender liner and secure in place with plastic pop rivets (Item 15).

27

Loosely install the black hose clamp (Item 20) to the base of the air ram assembly (Item 2). Install the air ram assembly onto the snorkel body. Align the air ram assembly and tighten the black hose clamp (Item 20).



It is the installer's responsibility to ensure that all connections are watertight.